

IRXONE
COLUMN SPEAKER WITH BLUETOOTH®

User's Guide

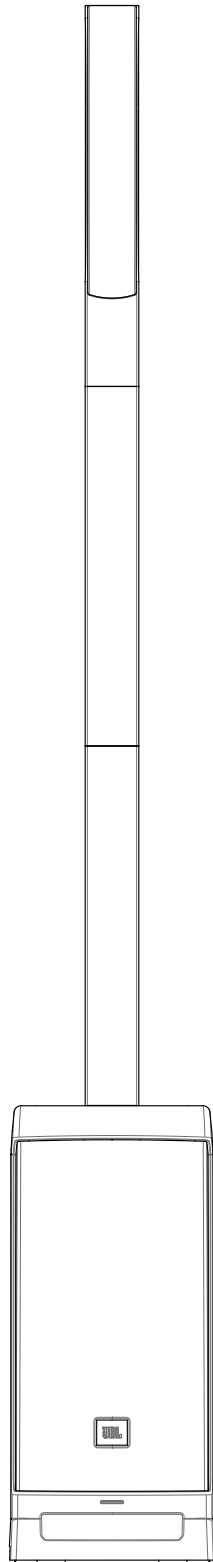

Section 1: Important Safety Instructions	5
Section 2: Precautions	6
Section 3: Introduction to the IRX ONE system.....	8
Getting Started.....	8
P.A. Basics	11
Getting Acquainted with IRX ONE.....	11
Audio Inputs	12
Mono Mic/Line Inputs	12
Phantom Power Disclaimer	13
Bluetooth Input	14
Audio Outputs	14
Section 4: System Specifications.....	15
Section 5: Cables & Connectors	16
Section 6: Contact Information	17
Section 7: Warranty information	18



The IRX ONE® speaker system covered by this manual is not intended for use in high moisture environments. Moisture can damage the speaker cone and surround and cause corrosion of electrical contacts and metal parts. Avoid exposing the speakers to direct moisture. Keep speakers out of extended or intense direct sunlight. The driver suspension will prematurely dry out and finished surfaces may be degraded by long-term exposure to intense ultra-violet (UV) light. The IRX ONE® system can generate considerable energy. When placed on a slippery surface such as polished wood or linoleum, the speaker may move due to its acoustical energy output. Precautions should be taken to assure that the speaker does not fall off a stage or table on which it is placed.

CARE & CLEANING

IRX ONE® speaker system may be cleaned with a dry cloth. Do not allow moisture into any of the openings in the system. Ensure that the system is unplugged from the AC outlet before cleaning.

THIS APPARATUS CONTAINS POTENTIALLY LETHAL VOLTAGES. TO PREVENT ELECTRIC SHOCK OR HAZARD, DO NOT REMOVE CHASSIS, MIXER MODULE, OR AC INPUT COVERS. NO USER SERVICEABLE PARTS INSIDE. REFER SERVICING TO QUALIFIED SERVICE PERSONNEL.

WEEE Notice



The Directive 2012/19/EU on Waste Electrical and Electronic Equipment (WEEE), which entered into force as European law on 14/02/2014, resulted in a major change in the treatment of electrical equipment at end-of-life.

The purpose of this Directive is, as a first priority, the prevention of WEEE, and in addition, to promote the reuse, recycling and other forms of recovery of such wastes so as to reduce disposal. The WEEE logo on the product or on its box indicating collection for electrical and electronic equipment consists of the crossed-out wheeled bin, as shown below.

This product must not be disposed of or dumped with your other household waste. You are liable to dispose of all your electronic or electrical waste equipment by relocating over to the specified collection point for recycling of such hazardous waste. Isolated collection and proper recovery of your electronic and electrical waste equipment at the time of disposal will allow us to help conserving natural resources. Moreover, proper recycling of the electronic and electrical waste equipment will ensure safety of human health and environment. For more information about electronics and electrical waste equipment disposal, recovery, and collection points, please contact your local city center, household waste disposal service, shop from where you purchased the equipment, or manufacturer of the equipment.

RoHS Compliance

This product is in compliance with Directive 2011/65/EU and (EU) 2015/863 of the European Parliament and of the Council of 31/03/2015 on the restriction of the use of certain hazardous substances in electrical and electronic equipment.

REACH

REACH (Regulation No 1907/2006) addresses the production and use of chemical substances and their potential impacts on human health and the environment. Article 33 (1) of REACH Regulation requires suppliers to inform the recipients if an article contains more than 0.1% (per weight per article) of any substance(s) on the Substances of Very High Concern (SVHC) Candidate List ('REACH candidate list').

This product contains the substance "lead" (CAS-No. 7439-92-1) in a concentration of more than 0.1% per weight.

At the time of release of this product, except for the lead substance, no other substances of REACH candidate list are contained in a concentration of more than 0.1% per weight in this product.

Note: on June 27, 2018, lead was added to the REACH candidate list. The inclusion of lead in the REACH candidate list does not mean that lead-containing materials pose an immediate risk or results in a restriction of permissibility of its use.

SECTION 1: IMPORTANT SAFETY INSTRUCTIONS

NOTE: This product is intended for PROFESSIONAL USE ONLY.

1. READ these instructions.
2. KEEP these instructions.
3. HEED all warnings.
4. FOLLOW all instructions.
5. DO NOT use this apparatus near water.
6. CLEAN ONLY with dry cloth.
7. DO NOT block any ventilation openings. Install in accordance with the manufacturer's instructions.
8. DO NOT install near any heat sources such as radiators, heat registers, stoves, or other apparatus.
9. DO NOT defeat the safety purpose of the polarized or grounding-type plug. A polarized plug has two blades with one wider than the other. A grounding-type plug has two blades and a third grounding prong. The wide blade or the third prong is provided for your safety. If the provided plug does not fit into your outlet, consult an electrician for replacement of the obsolete outlet.
10. PROTECT the power cord from being walked on or pinched, particularly at plugs, convenience receptacles, and the point where they exit from the apparatus.
11. ONLY USE attachments/accessories specified by the manufacturer.
12.  Use only with the cart, stand, tripod, bracket, or table specified by the manufacturer, or sold with the apparatus. When a cart is used, use caution when moving the cart/apparatus combination to avoid injury from tip-over.
13. UNPLUG this apparatus during lightning storms or when unused for long periods of time.
14. REFER all servicing to qualified service personnel. Servicing is required when the apparatus has been damaged in any way, such as power supply cord or plug is damaged, liquid has been spilled or objects have fallen into the apparatus, the apparatus has been exposed to rain or moisture, does not operate normally, or has been dropped.
15. DO NOT expose this equipment to dripping or splashing and ensure that no objects filled with liquids, such as vases, are placed on the apparatus.
16. To completely disconnect this apparatus from the AC Mains, disconnect the power supply cord plug from the AC receptacle.
17. Where the mains plug or an appliance coupler is used as the disconnect device, the disconnect device shall remain readily operable.
18. DO NOT overload wall outlets or extension cords beyond their rated capacity as this can cause electric shock or fire.
19. For adequate ventilation, do not install this equipment in a confined or enclosed space, such as a book case or similar unit. Product ventilation should not be impeded by covering the ventilation openings with items such as newspaper, tablecloths, curtains, etc.



The exclamation point, within an equilateral triangle, is intended to alert the user to the presence of important operating and maintenance (servicing) instructions in the literature accompanying the product.



The lightning flash with an arrowhead symbol within an equilateral triangle is intended to alert the user to the presence of uninsulated "dangerous voltage" within the product's enclosure that may be sufficient in magnitude to constitute a risk of electrical shock to persons.

WARNING: To reduce the risk of fire or electrical shock, do not expose this apparatus to rain or moisture.

WARNING: No naked flame sources – such as lighted candles – should be placed on the product.

WARNING: Equipment shall be connected to a MAINS socket outlet with a protective earthing connection.

SECTION 2: PRECAUTIONS

WARNING: This product is intended to be operated ONLY from the voltages listed on the back panel. Operation from other voltages other than those indicated may cause irreversible damage to the product and void the product's warranty. The use of AC Plug Adapters is cautioned because it can allow the product to be plugged into voltages in which the product was not designed to operate. If you are unsure of the correct operational voltage, please contact your local distributor and/or retailer. If the product is equipped with a detachable power cord, use only the type provided, or specified, by the manufacturer or your local distributor.

OPERATING TEMPERATURE RANGE: -20°C - 40°C (-4°F - 104°F)



WARNING: Do Not Open! Risk of Electrical Shock. Voltages in this equipment are hazardous to life. No user-serviceable parts inside. Refer all servicing to qualified service personnel.

Place the equipment near a main power supply outlet and make sure that you can easily access the power breaker switch.

DO NOT UNDER ANY CIRCUMSTANCES OPERATE THE UNIT WITH THE WRONG VOLTAGE SELECTED. DOING SO MAY RESULT IN SERIOUS DAMAGE TO YOUR PA SYSTEM WHICH WILL NOT BE COVERED BY WARRANTY.

FCC AND CANADA EMC COMPLIANCE INFORMATION:

This device complies with Part 15 of the FCC Rules. Operation is subject to the following two conditions:

1. This device may not cause harmful interference, and (2) this device must accept any interference received, including interference that may cause undesired operation.

CAUTION: Changes or modifications not expressly approved by the manufacturer could void the user's authority to operate this device.

NOTE: This equipment has been tested and found to comply with the limits for a Class B digital device, pursuant to Part 15 of the FCC Rules. These limits are designed to provide reasonable protection against harmful interference in a residential installation. This equipment generates uses and can radiate radio frequency energy and, if not installed and used in accordance with the instructions, may cause harmful interference to radio communications. However, there is no guarantee that interference will not occur in a particular installation. If this equipment does cause harmful interference to radio or television reception, which can be determined by turning the equipment off and on, the user is encouraged to try to correct the interference by one or more of the following measures: Reorient or relocate the receiving antenna. Increase the separation between the equipment and receiver. Connect the equipment into an outlet on a circuit different from that to which the receiver is connected. Consult the dealer or an experienced radio/TV technician for help.

CAUTION: This product is for non-residential use only.

WARNING: This equipment is compliant with Class B of CISPR 32. In a residential environment this equipment may cause radio interference.

CAN ICES-003(B)/NMB-003(B)



Protective earthing terminal. The apparatus should be connected to a mains socket outlet with a protective earthing connection.

WIRELESS TRANSMITTER COMPLIANCE INFORMATION:

The term "IC:" before the radio certification number only signifies that Industry Canada technical specifications were met.

Le terme «IC:» avant le numero de certification radio signifie seulement que les specifications techniques d'Industrie Canada ont ete respectees.

This device contains licence-exempt transmitter(s)/receiver(s) that comply with Innovation, Science and Economic Development Canada's licence-exempt RSS(s). Operation is subject to the following two conditions (1) this device may not cause harmful interference, and (2) this device must accept any interference, including interference that may cause undesired operation of the device.

Cet appareil contient des émetteurs / récepteurs exemptés de licence conformes aux RSS (RSS) d'Innovation, Sciences et Développement économique Canada. L'exploitation est autorisée aux deux conditions suivantes : (1) l'appareil ne doit pas produire de brouillage, et (2) l'utilisateur de l'appareil doit accepter tout brouillage radioélectrique subi, même si le brouillage est susceptible d'en compromettre le fonctionnement.

This equipment complies with FCC and IC radiation exposure limits set forth for an uncontrolled environment. This equipment should be installed and operated with minimum distance 20cm between the radiator and your body. This transmitter must not be co-located or operating in conjunction with any other antenna or transmitter.

Cet appareil est conforme a FCC et IC !'exposition aux rayonnements limites fixees pour un environnement non controle. Cet appareil doit etre installe et utilise avec une distance minimale de 20cm entre le radiateur et votre corps. Cet transmetteur ne doit pas etre cositue ou operant en liaison avec toute autre antenne ou transmetteur.

EU COMPLIANCE INFORMATION:

Hereby, HARMAN Professional, Inc., declares that the equipment type IRX ONE® speaker system in compliance to the following: European Union Restriction of Hazardous Substances Recast (RoHS2) Directive 2011/65/EU; European Union WEEE (recast) Directive 2012/19/EU; European Union Registration, Evaluation, Authorization and Restriction of Chemicals (REACH) Directive 1907/2006; European Radio Equipment Directive (RED) 2014/53/EU

You may obtain a free copy of the full Declaration of Conformity by visiting:
<http://www.jblpro.com/www/product-support/downloads>

WIRELESS FREQUENCY RANGE AND WIRELESS OUTPUT POWER:
2402MHz ~ 2480MHz
6.00mW

UKCA COMPLIANCE INFORMATION:

Hereby, HARMAN Professional, Inc., declares that the equipment type IRXONE is in compliance to the following: UK Electromagnetic Compatibility Regulations 2016 (UK SI 2016 No. 091) , The Electrical Equipment (Safety) Regulations 2016(UK SI 2016 No. 1 01 Restriction of the Use of Certain Hazardous Substances in Electrical and Electronic Equipment Regulations 2012 (RoHS2) UK SI 2012 No. 3032; Radio Equipment Regulations 2017; SI 2016 No.1091; SI 2016 No.1101; SI 2017 No.1206 and all other applicable UK regulations. The complete declaration of conformity can be found at: www.jblpro.com/www/product/downloads.

ENVIRONMENTAL:



此标识适用于在中华人民共和国销售的电子信息产品。标识中间的数字为环保实用期限的年数。

SECTION 3: INTRODUCTION TO THE IRX ONE SYSTEM

Thank you for choosing the JBL IRX ONE system. The IRX ONE is a portable all-in-one linear-array system featuring multiple input channels with individual tone controls, music ducking, phantom power, fixed presets and Bluetooth® audio streaming. With a design that stores all the components into one lightweight unit for one-hand carry, the IRX ONE provides a versatile PA system that is perfect for situations where ease and portability are just as important as legendary JBL sound.

The following items are included in the IRX ONE package:

- 1 JBL IRX ONE base
- 2 listening height spacers
- 1 column speaker array
- 1 power cable
- Quick start guide

GETTING STARTED

1. Remove the IRX ONE system from the carton.
2. Push the latch lever and lift the cover, then remove the spacers and column speaker array from the back of the unit.

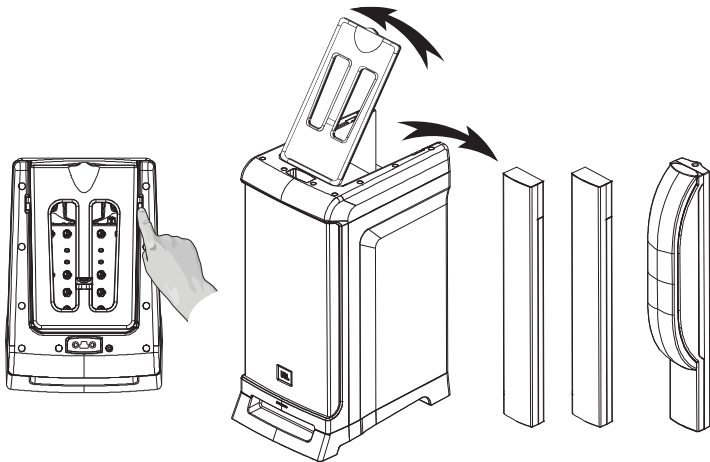

3. Place spacers for the desired listening level, then attach the column speaker array.

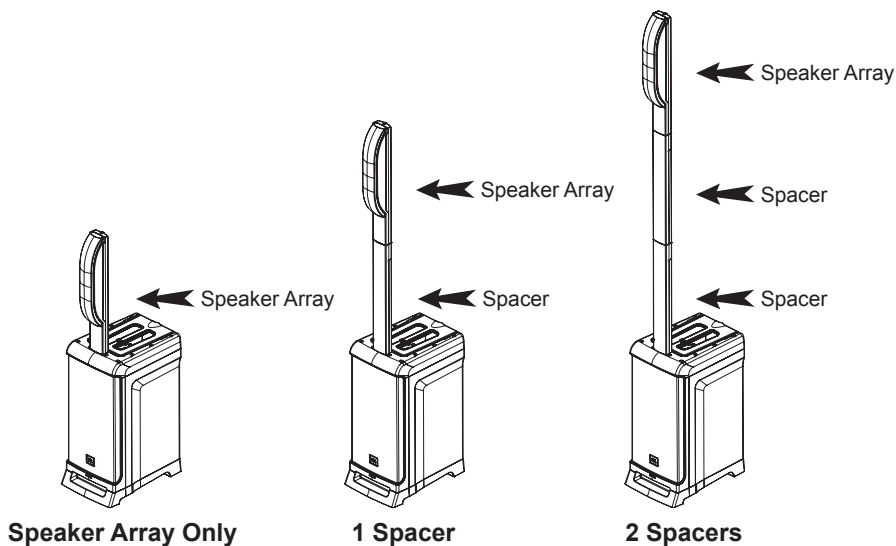

4. Connect the female end of the power cable to the IRX ONE and plug the male end into a wall socket.

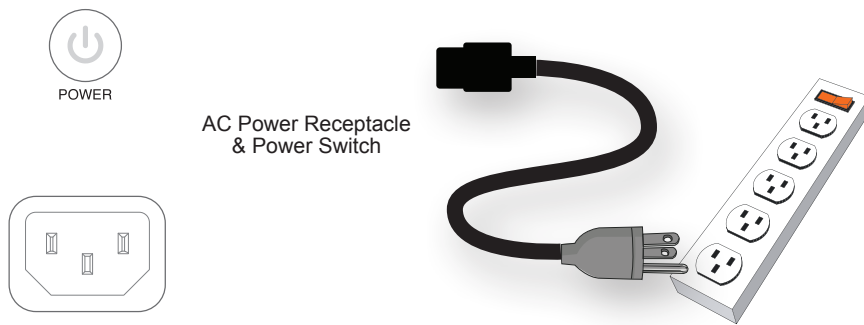

5. Turn the MAIN VOLUME and CHANNEL VOLUME controls all the way to the left.

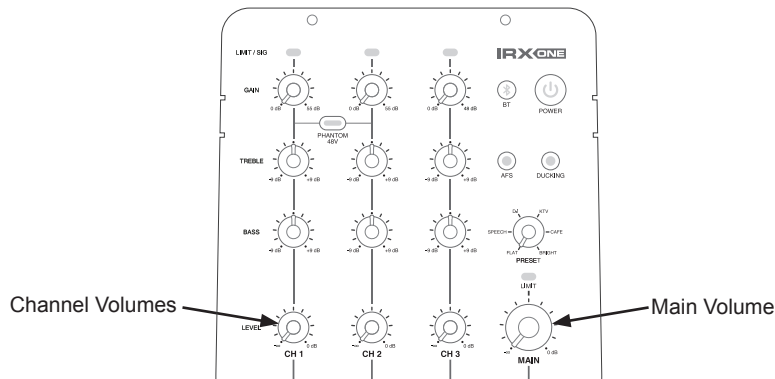

6. Make audio connections.

1. Set the EQ Preset based on your application.
2. Adjust the individual gain levels for each connected input. Microphone inputs will be near the 3 o'clock position, and line source will be near 9 o'clock. If using condenser mics, connect to CH1 and/or CH2, and push the PHANTOM button. See "Phantom Power Disclaimer" on page 10 for important information about using phantom power.

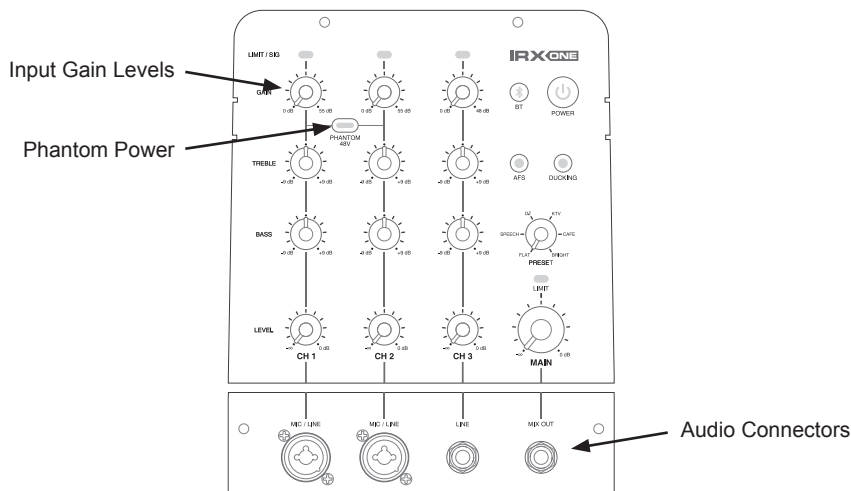

-
7. Press the POWER button. The POWER button LED indicator will illuminate, as well as the LED on the front.



AC Power Button

8. If connecting a Bluetooth device for audio streaming, follow these steps:
 - a. Enable Bluetooth on your source device.
 - b. Press the BLUETOOTH button.
 - c. Find “JBL IRX ONE” on your device and select it.

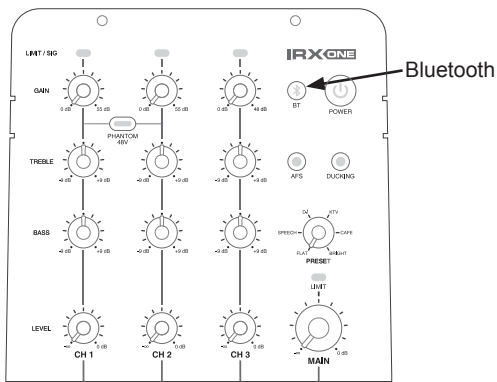

9. Set the Channel Volume controls to 12 o'clock.
10. Slowly turn the Main Volume control to the right until the desired volume is reached.
11. Fine tune the Channel Volume controls for the desired mix balance. If using Bluetooth audio streaming, adjust the Bluetooth streaming device's volume control to balance it with the other channels.
12. Add the finishing touches by adjusting the tone of each channel using the TREBLE and BASS controls.
13. Enjoy your audio!

P.A. BASICS

A mixing board is actually a very simple device that takes the audio input signals (from the input channels) and “mixes” them to the outputs. The mixing board controls will typically enable the user to blend the input channel signal levels, affect their tone.

GETTING ACQUAINTED WITH IRX ONE

The powered mixer section of the IRX ONE system houses the mixing board and power amplifier. Here, all of the microphones, musical instruments, and external sound sources (such as MP3 players, CD players, or Bluetooth audio sources) can be connected.

The Mix OUT output can be used to connect multiple IRX ONE line arrays together for increased sound output.

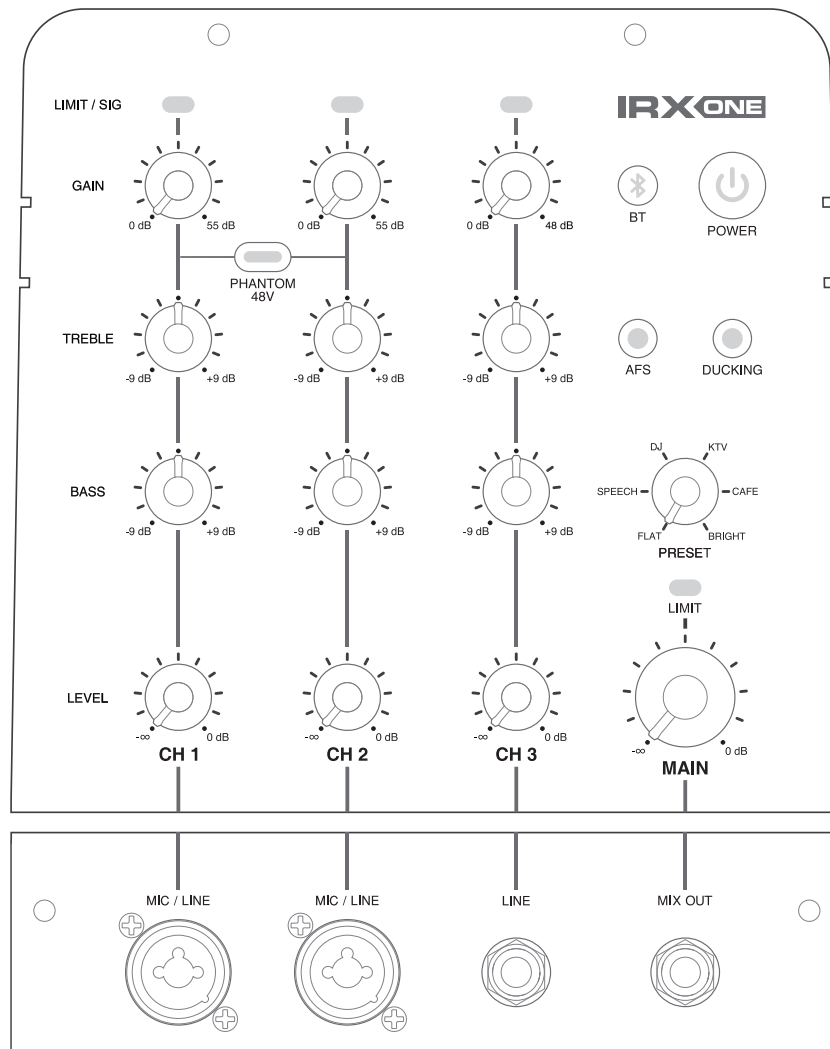

Let's take a look at the audio input channels first.

AUDIO INPUTS

The IRX ONE has 4 inputs: 3 mono inputs, and a Bluetooth audio streaming input. All of the inputs will route to the speakers and the MIX OUT 1/4".

MONO MIC/LINE INPUTS

Moving from left to right there are three identical input strips comprised of: (from top to bottom) a gain control (mic/line), treble control, bass control, and a level control. Between the CH1 & CH2 strip, there is also a phantom power enable button for channels 1 & 2.

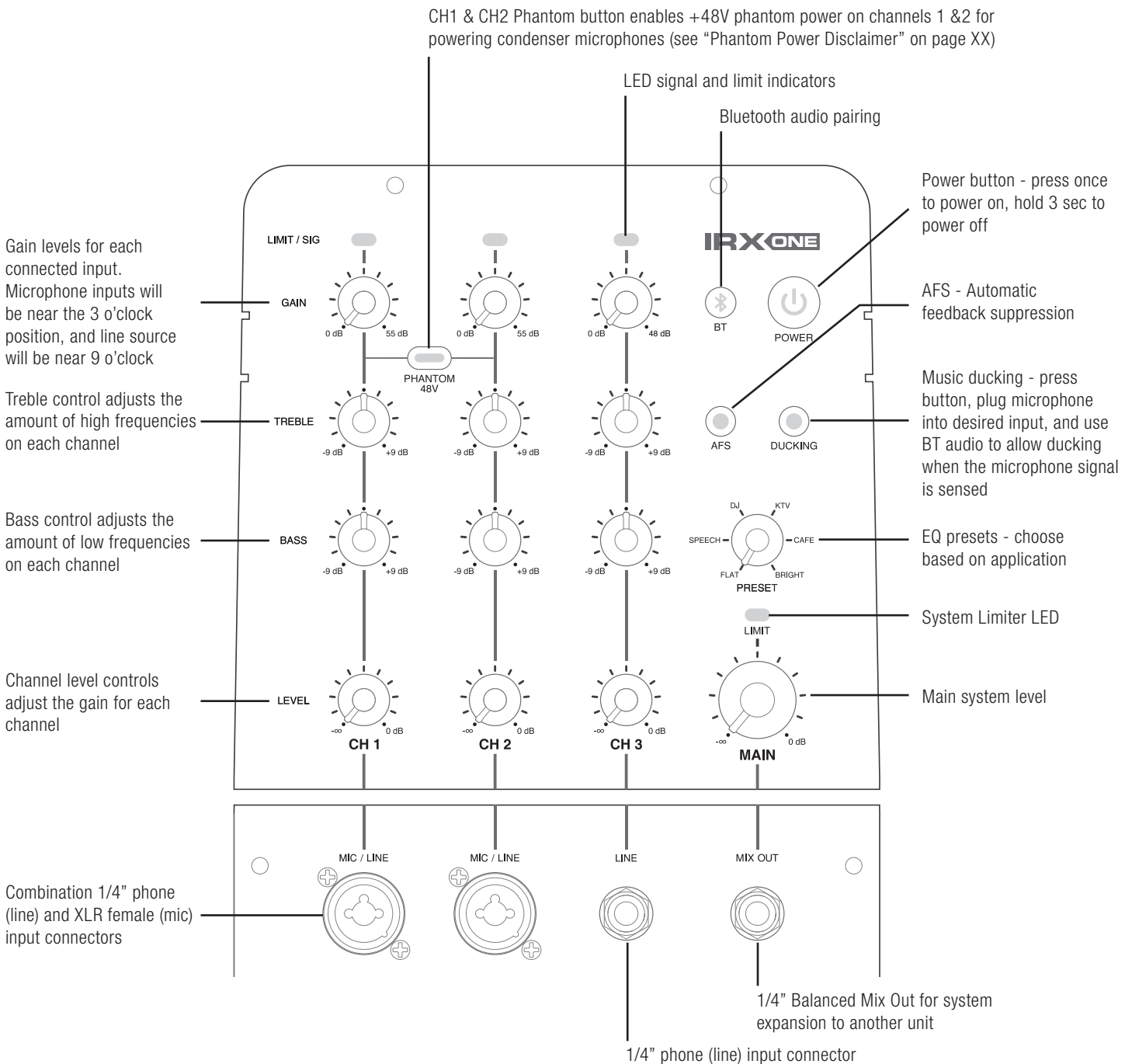

PHANTOM POWER DISCLAIMER

When using condenser microphones, +48V phantom power is required to be present at the contacts of the microphone (XLR) connector for the microphone to operate correctly. When phantom power is enabled, it is applied to both the CH1 and CH2 XLR inputs. Ensure that phantom power is off when not required.

To prevent damage to the IRX ONE or external devices when using condenser microphones, always turn down all IRX ONE output controls and ensure the +48V phantom power is off before connecting the microphone. Once the condenser microphone has been connected, enable the +48V phantom power, then raise the output controls to the desired levels.

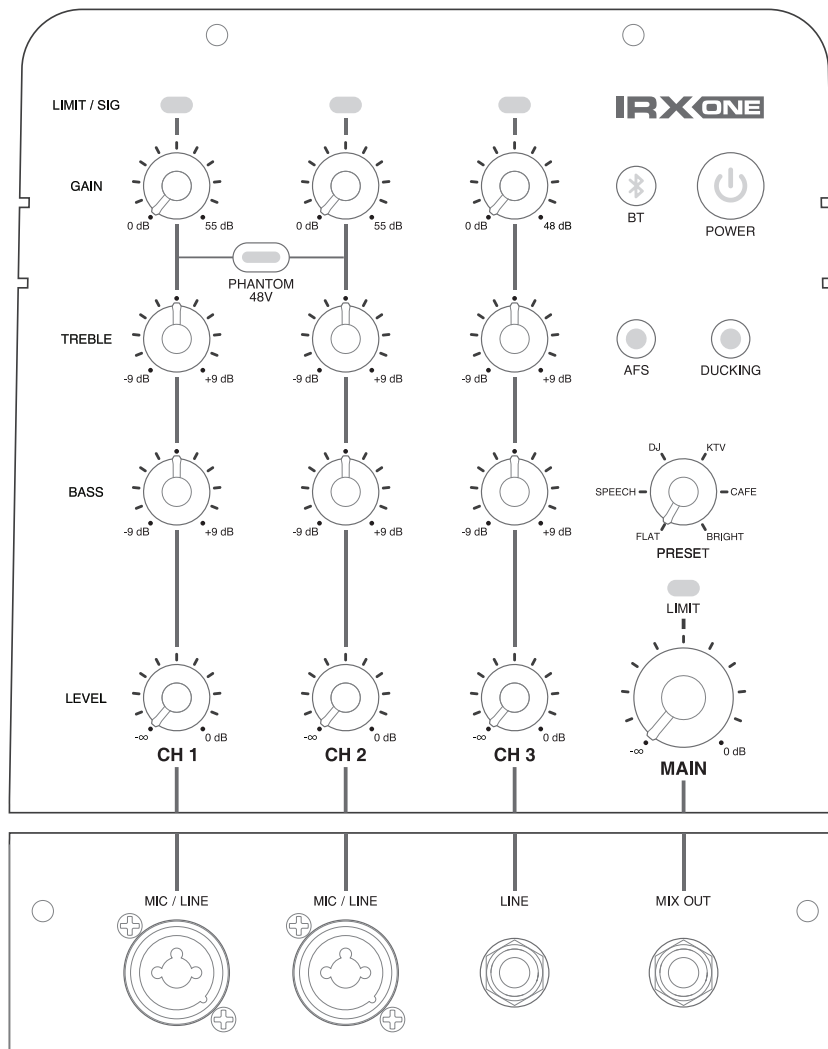

WARNING

Do not connect unbalanced sources to the XLR inputs when +48V phantom power is engaged. Doing so may cause damage to your device. You should also ensure that your balanced sources are capable of handling +48V phantom power, as it can damage certain balanced sources.

BLUETOOTH INPUT

The IRX ONE comes equipped with the ability to stream Bluetooth audio for music playback or backing tracks. To connect a Bluetooth device, first press the BLUETOOTH PAIR button on the back of the IRX ONE. Then select “JBL IRX ONE” from the source device to complete the pairing. The level of the Bluetooth device relative to other source channels can be controlled from the Bluetooth device. To turn bluetooth off, press and hold the bluetooth button for 5 or more seconds.

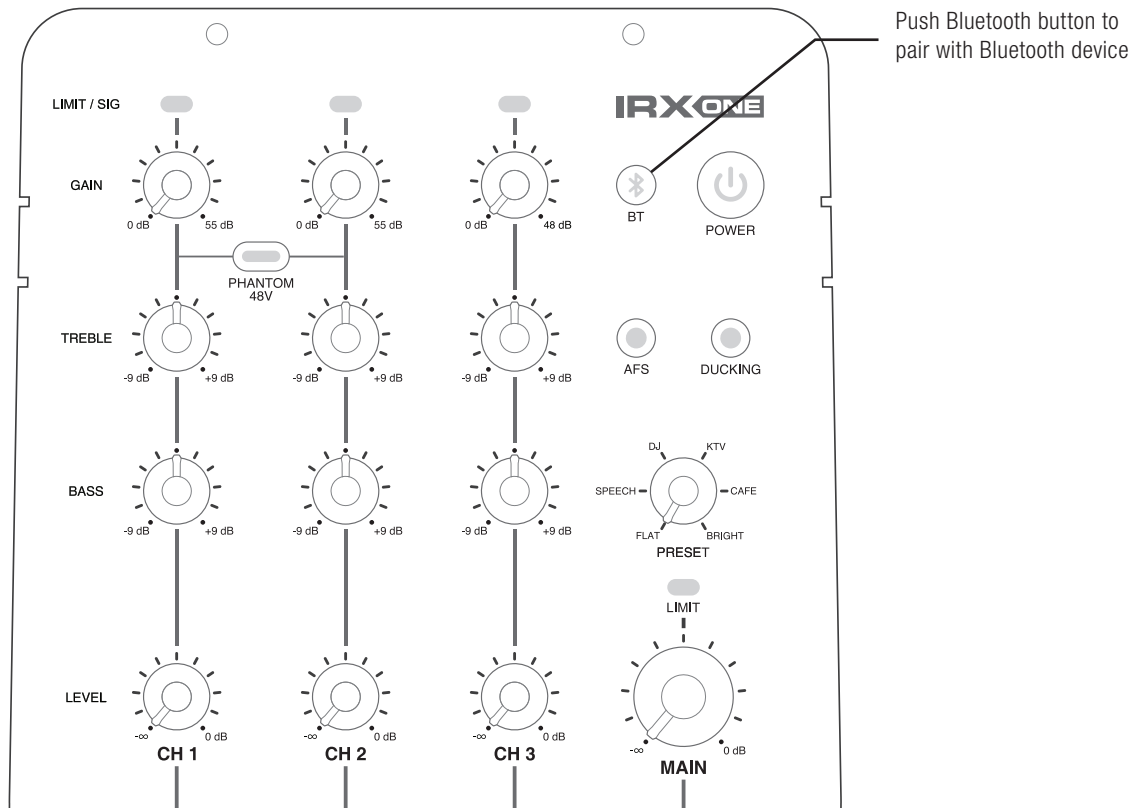

AUDIO OUTPUTS

MIX OUT output can be connected to the 1/4" input of another JBL IRX ONE to expand the system for higher output capabilities

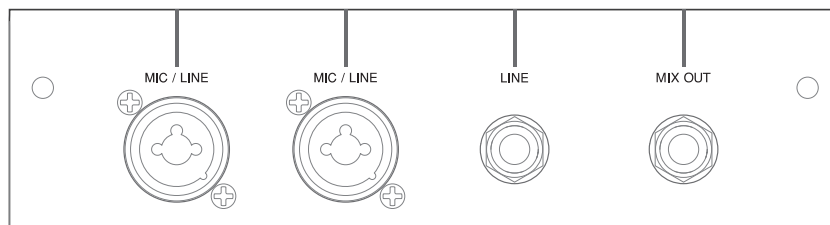

SECTION 4: SYSTEM SPECIFICATIONS

TECHNICAL SPECIFICATIONS

System Type	Column Speaker with Bluetooth
Woofers Size	8inch bass-reflex woofer
Woofers Magnet	Ferrite Magnet
Woofers Voice Coil	38.4mm
Tweeter Size	6 x 2inch HF drivers
Tweeter Magnet	Neo Magnet
Transducer Impedance	Woofers: 2ohm; Tweeter unit: 4ohm(Tweeter Array: 2ohm)
Max SPL	118dB (peak)
Freq Range -10	40Hz ~ 20KHz @ 4pi
Freq Range -3	50Hz ~ 18KHz @ 4pi
Hor Dispersion	160
Vert Dispersion	80
Power Rating	1300W Peak
AC Power Input	100V - 120V or 220 - 240V
Cooling	No fan
Input Impedance Mic	4.4K Ω
Input Impedance HiZ	1M Ω
Input Gain Mic	55dB
Input Gain HiZ	48dB
Crossover Freq	260Hz
I/O	x2 Mic/line XLR Combo
	x1 HiZ In - 6.3mm jack
	Bluetooth SBC
	Mix Out - 6.3mm jack
Cabinet	PP
Grille	Steel
Suspension/Mount	None
Handles	Top
Net (kg)	15.55
Gross Weight (kg)	18.388
Product Dims (mm)	597MM X 400.5 X 267.5
Shipping Dims (mm)	725MM X 519 X 395

SECTION 5: CABLES & CONNECTORS

XLR/F to XLR/M Microphone Cable	The standard cable for interconnection of microphone and line-level signals in professional audio systems. Example: Microphone to mixer.
TRS (balanced) 1/4" phone to XLR/M cable	For connecting balanced devices with 1/4" phone; may be used interchangeably.
TRS (unbalanced) 1/4" phone to XLR/M cable	For connecting instruments with unbalanced outputs to balanced XLR inputs.
TS (unbalanced) 1/4" phone to XLR/M cable	This cable is electrically identical to "TRS" (unbalanced) 1/4" phone and may be used interchangeably.
XLR/M to RCA (phono) cable	Connects consumer audio products and some DJ mixer outputs to professional audio equipment inputs.
TS (unbalanced) 1/4" phone to RCA (phono) cable	Connects an unbalanced 1/4" output to an RCA input.
TRS 1/4" phone to dual 1/4" phone cable	Splits a stereo output into separate left/right signals. Also used for connecting signal processors to mixer insert jacks.
XLR/F to XLR/M audio ground lift adapter	Used for breaking ground loops between interconnected devices — works with balanced inputs and outputs only.

XLR/F to XLR/M Microphone Cable

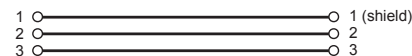

TRS (Balanced) 1/4" Phone to XLR/M Cable



TRS (Unbalanced) 1/4" Phone to XLR/M Cable

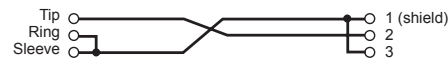

TS (Unbalanced) 1/4" Phone to XLR/M Cable



XLR/M to RCA (Phono) Cable

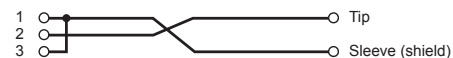

TS (Unbalanced) 1/4" Phone to RCA (Phono) Cable

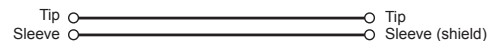

TRS 1/4" Phone to dual TS 1/4" Phone Cable

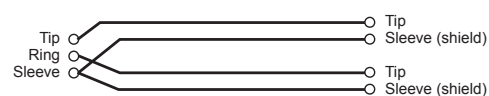

XLR/F to XLR/M Audio Ground Lift Adapter

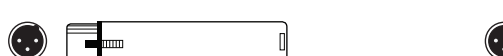

SECTION 6: CONTACT INFORMATION



Mailing Address:

JBL Professional
8500 Balboa Blvd.
Northridge, CA 91329

Shipping Address:

JBL Professional
8500 Balboa Blvd., Dock 15
Northridge, CA 91329

(Do not return product to this address without first obtaining prior authorization from JBL)

Customer Service:

Monday through Friday
8:00am - 6:00pm Central Time

(844) 776-4899

Help.HarmanPro.com

On The World Wide Web:

www.jblpro.com

Professional Contacts, Outside the USA:

Contact the JBL Professional Distributor in your area.

A complete list of JBL Professional international distributors is provided at our U.S.A. website: www.jblpro.com

SECTION 7: WARRANTY INFORMATION

The JBL Limited Warranty on professional loudspeaker products (except for enclosures) remains in effect for five years from the date of the first consumer purchase. JBL amplifiers are warranted for three years from the date of original purchase. Enclosures and all other JBL products are warranted for two years from the date of original purchase.

Who Is Protected By This Warranty?

Your JBL Warranty protects the original owner and all subsequent owners so long as: A.) Your JBL product has been purchased in the Continental United States, Hawaii or Alaska. (This Warranty does not apply to JBL products purchased elsewhere except for purchases by military outlets. Other purchasers should contact the local JBL distributor for warranty information.); and B.) The original dated bill of sale is presented whenever warranty service is required.

What Does The JBL Warranty Cover?

Except as specified below, your JBL Warranty covers all defects in material and workmanship. The following are not covered: Damage caused by accident, misuse, abuse, product modification or neglect; damage occurring during shipment; damage resulting from failure to follow instructions contained in your Instruction Manual; damage resulting from the performance of repairs by someone not authorized by JBL; claims based upon any misrepresentations by the seller; any JBL product on which the serial number has been defaced, modified or removed.

Who Pays For What?

JBL will pay all labor and material expenses for all repairs covered by this warranty. Please be sure to save the original shipping cartons because a charge will be made if replacement cartons are requested. Payment of shipping charges is discussed in the next section of this warranty.

How To Obtain Warranty Performance

If your JBL product ever needs service, write or telephone us at JBL Incorporated (Attn: Customer Service Department), 8500 Balboa Boulevard, PO. Box 2200, Northridge, California 91329 (818/893-8411). We may direct you to an authorized JBL Service Agency or ask you to send your unit to the factory for repair. Either way, you'll need to present the original bill of sale to establish the date of purchase. Please do not ship your JBL product to the factory without prior authorization. If transportation of your JBL product presents any unusual difficulties, please advise us and we may make special arrangements with you. Otherwise, you are responsible for transporting your product for repair or arranging for its transportation and for payment of any initial shipping charges. However, we will pay the return shipping charges if repairs are covered by the warranty.

Limitation of Implied Warranties

ALL IMPLIED WARRANTIES, INCLUDING WARRANTIES OF MERCHANTABILITY AND FITNESS FOR PARTICULAR PURPOSE, ARE LIMITED IN DURATION TO THE LENGTH OF THIS WARRANTY.

EXCLUSION OF CERTAIN DAMAGES

JBL'S LIABILITY IS LIMITED TO THE REPAIR OR REPLACEMENT, AT OUR OPTION, OF ANY DEFECTIVE PRODUCT AND SHALL NOT INCLUDE INCIDENTAL OR CONSEQUENTIAL DAMAGES OF ANY KIND. SOME STATES DO NOT ALLOW LIMITATIONS ON HOW LONG AN IMPLIED WARRANTY LASTS AND/OR DO NOT ALLOW THE EXCLUSION OF INCIDENTAL OR CONSEQUENTIAL DAMAGES, SO THE ABOVE LIMITATIONS AND EXCLUSIONS MAY NOT APPLY TO YOU. THIS WARRANTY GIVES YOU SPECIFIC LEGAL RIGHTS, AND YOU MAY ALSO HAVE OTHER RIGHTS, WHICH VARY, FROM STATE TO STATE.

JBL Professional

8500 Balboa Blvd. Northridge, CA 91329 USA

IRX ONE